

PARTS GUIDE

SERIES SGD 1000

SLIDING GLASS DOOR SYSTEM

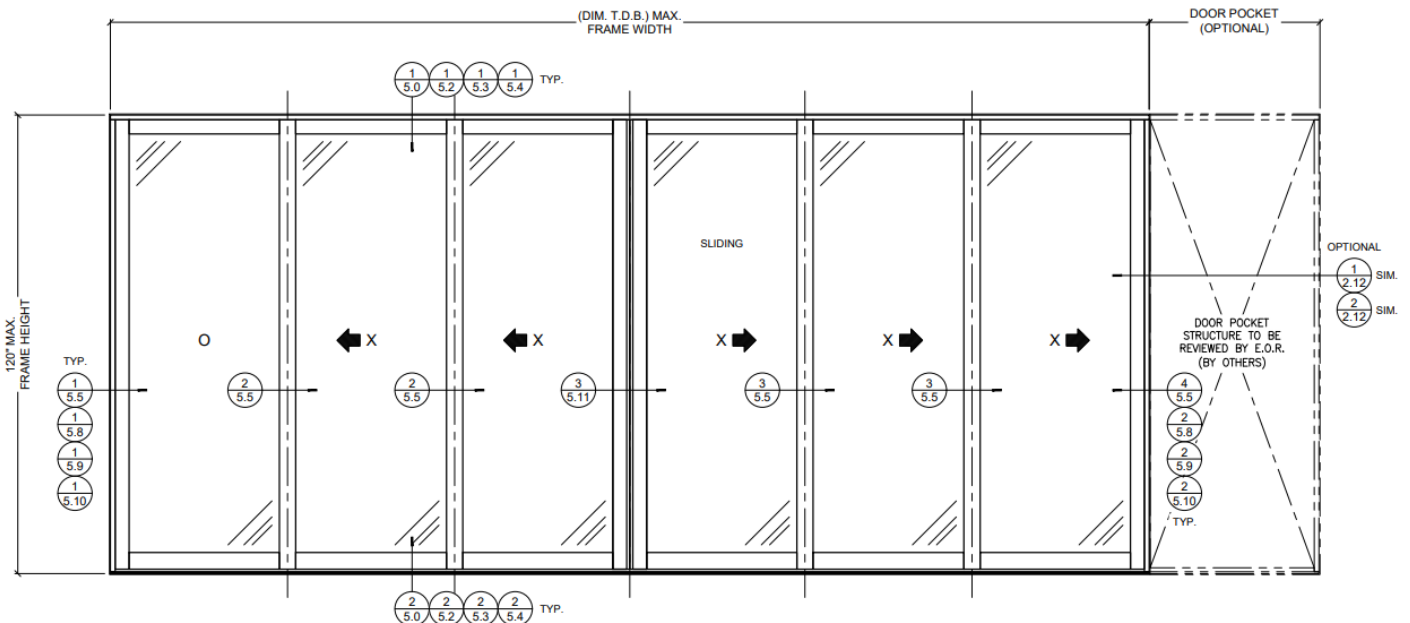

PANEL COMPONENTS – STILE

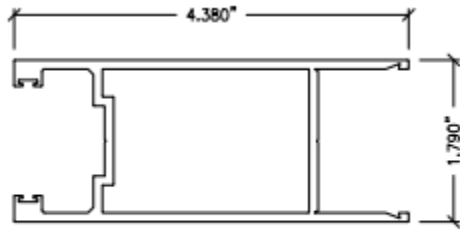

02 STD. DOOR STILE
DS-2

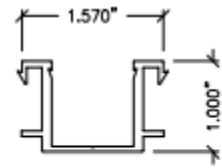

25 9/16" GLZ. STILE ADAPTER
ADPT-25

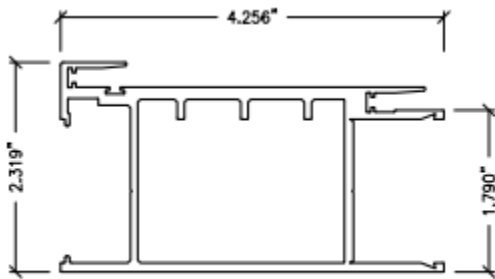

03 INTERLOCK STILE
IL-3

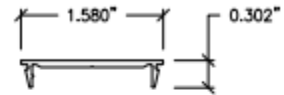

19 STILE SNAP COVER
AS-19

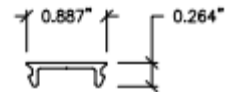

21 ANCHOR SNAP COVER
AS-20

PANEL COMPONENTS - STILE

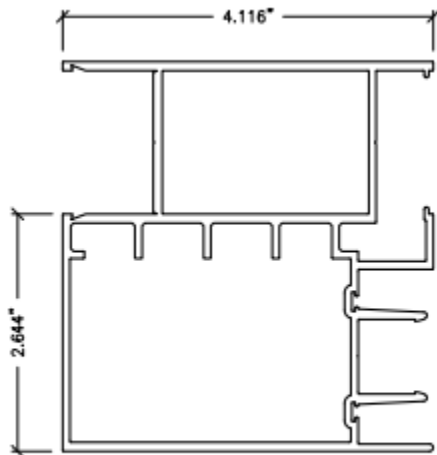

04 BUTT STILE (OFFSET)
BS-4

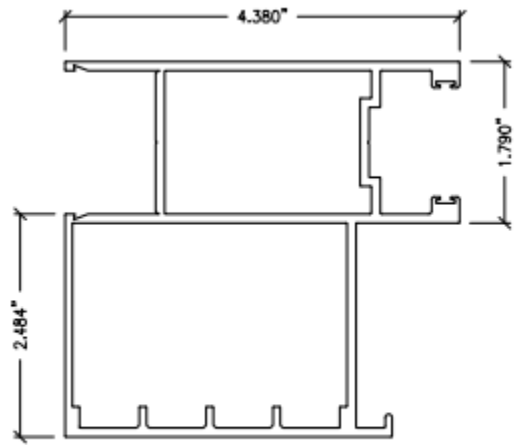

05 INTERLOCK BUTT STILE (FEMALE)
LIL-5

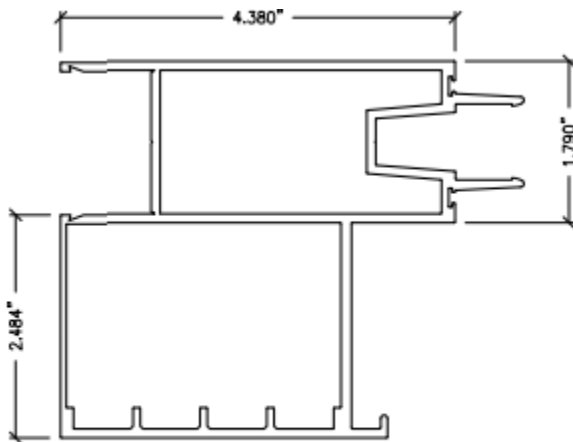

06 LOCK BUTT STILE (MALE)
LIL-6

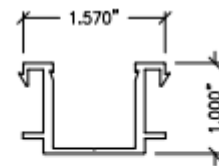

25 9/16" GLZ. STILE ADAPTER
ADPT-25

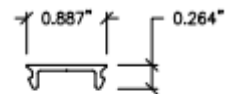

21 ANCHOR SNAP COVER
AS-20

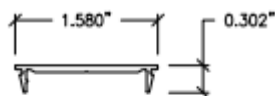

19 STILE SNAP COVER
AS-19

PANEL COMPONENTS - RAIL

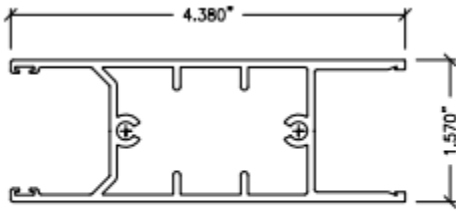

01 STD. DOOR RAIL
DR-1

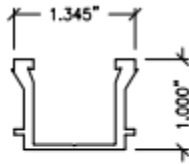

26 9/16" GLZ. RAIL ADAPTER
ADPT-26

PANEL COMPONENTS – STILE (CORNER DOOR)

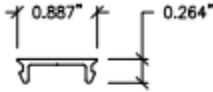
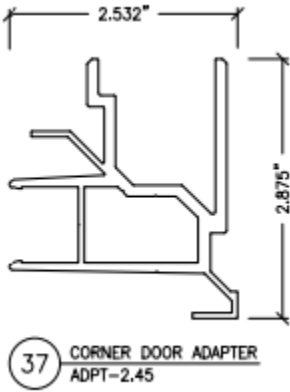
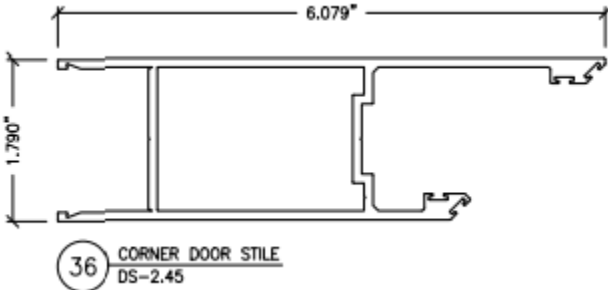

21 ANCHOR SNAP COVER
AS-20

FRAME COMPONENTS - HEAD

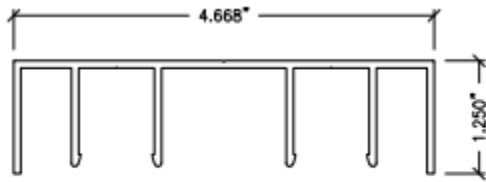

13 TWO-TRACK HEADER
2TRH-13

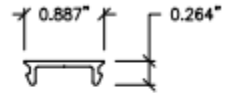

21 ANCHOR SNAP COVER
AS-20

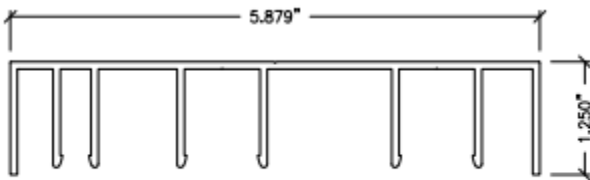

14 TWO-TRACK HEADER (W/ SCREEN)
2TRHWS-14

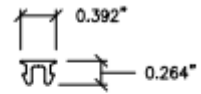

23 SCREEN SNAP COVER
AS-23

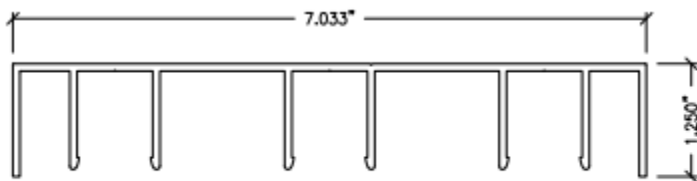

15 THREE-TRACK HEADER
3TRH-15

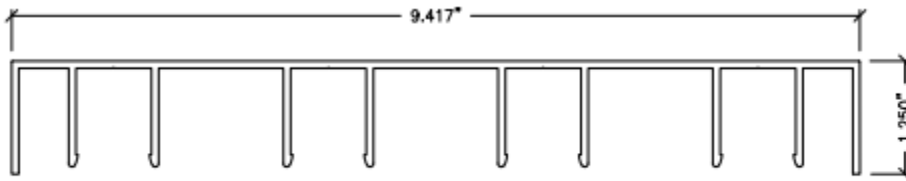

36 FOUR-TRACK HEADER
4TRH-36

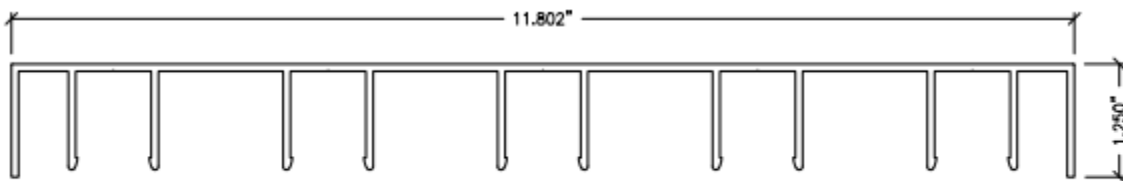

39 FIVE-TRACK HEADER
5TRH-39

FRAME COMPONENTS - JAMB

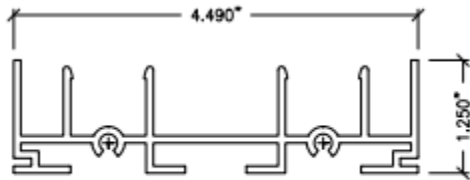

10 TWO-TRACK JAMB
2TRJ-10

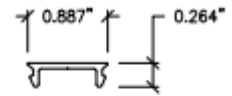

21 ANCHOR SNAP COVER
AS-20

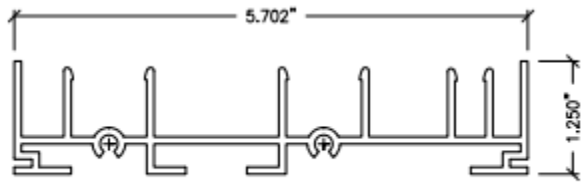

11 TWO-TRACK JAMB (W/ SCREEN)
2TJWS-11

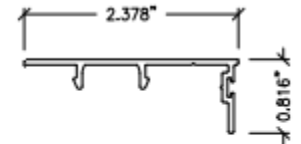

18 JAMB SNAP COVER
AS-18

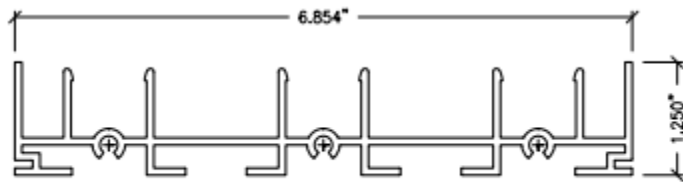

12 THREE-TRACK JAMB
3TRJ-12

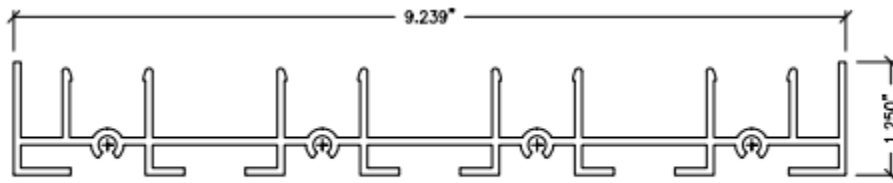

38 FOUR-TRACK JAMB
4TRJ-38

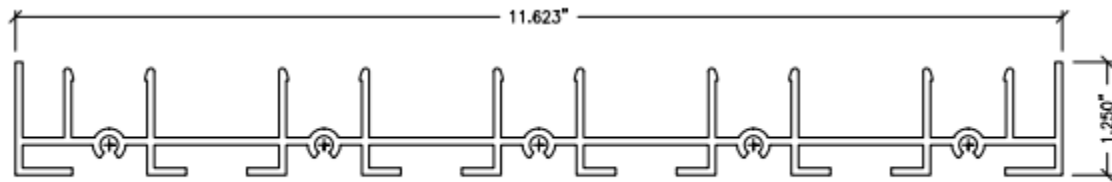

41 FIVE-TRACK JAMB
5TRJ-41

FRAME COMPONENTS - SILL

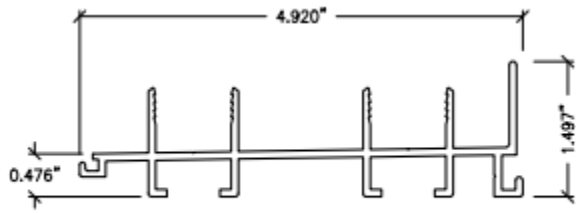

07 TWO-TRACK SILL
2TRS-7

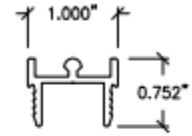

27 SNAP DOOR GUIDE RAIL
AS-27

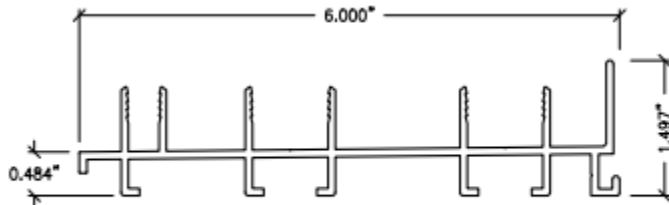

08 TWO-TRACK SILL (W/ SCREEN)
2TWS-8

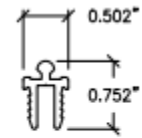

22 SNAP SCREEN GUIDE RAIL
AS-22

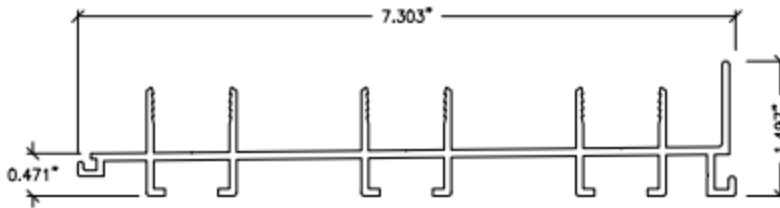

09 THREE-TRACK SILL
3TRS-9

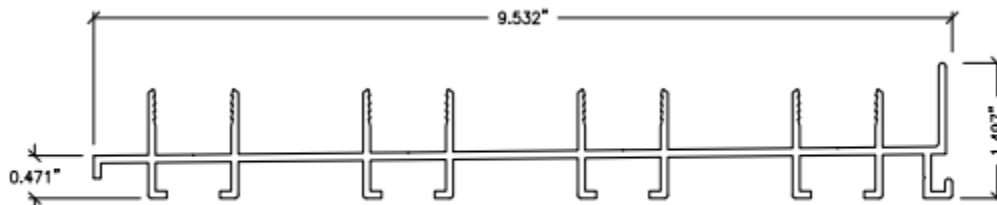

37 FOUR-TRACK SILL
4TRS-37

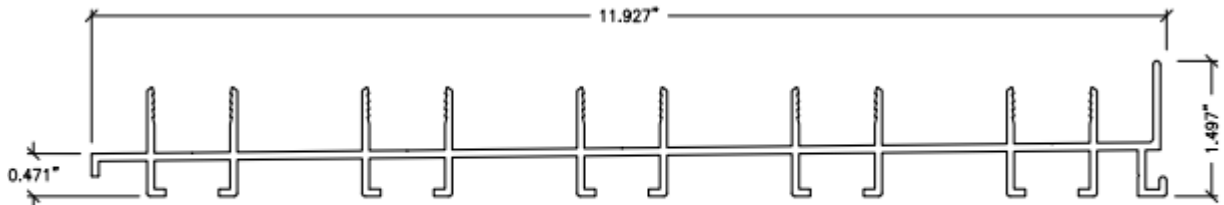

40 FIVE-TRACK SILL
5TRS-40

FRAME COMPONENTS - SILL RISERS

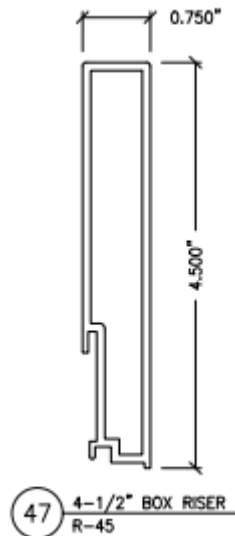
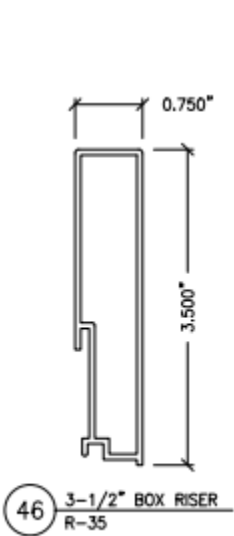
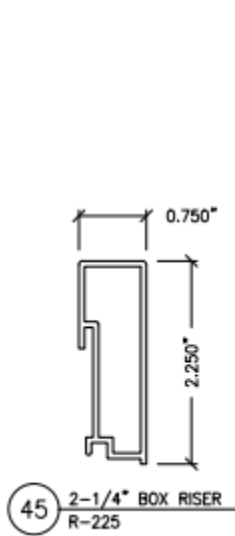
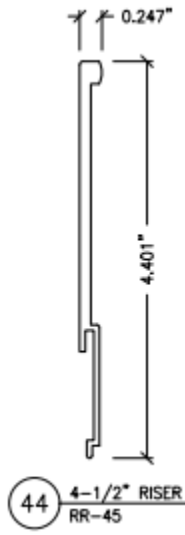
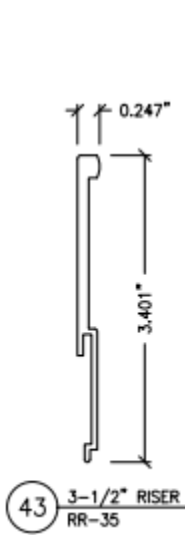
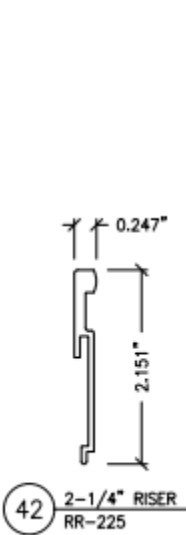

SCREEN COMPONENTS

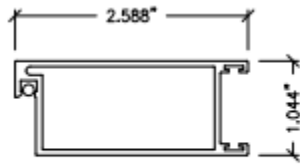

30 SCREEN STILE
SCN-30

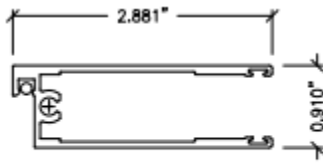

31 SCREEN RAIL
SCN-31REV

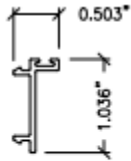

29 STILE SNAP COVER
SCN-29

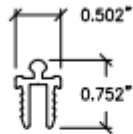

22 SNAP SCREEN GUIDE RAIL
AS-22

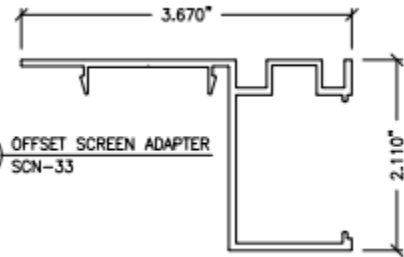

76 OFFSET SCREEN ADAPTER
SCN-33

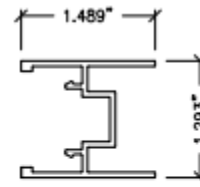

77 CENTER MEET SCREEN ADAPTER
SCN-32REV

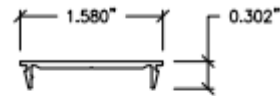

19 STILE SNAP COVER
AS-19

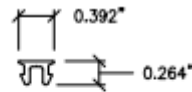

23 SCREEN SNAP COVER
AS-23

SCREEN COMPONENTS CONT'D

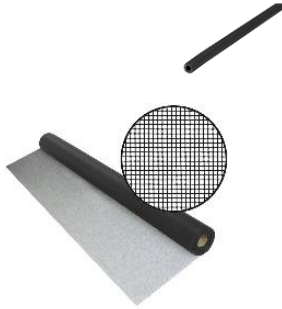

.185" X .070" SERRATED SCREEN SPLINE

PHIFER BETTERTVUE® SCREEN MESH

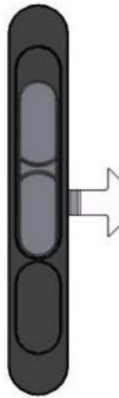

SCREEN PULL LATCH

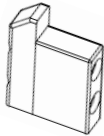

SCREEN KEEPER (JAMB STYLE)



SCREEN KEEPER (CENTER-MEET AND OXO STYLE)



SCREEN DOOR ROLLER

POCKET DOOR COMPONENTS

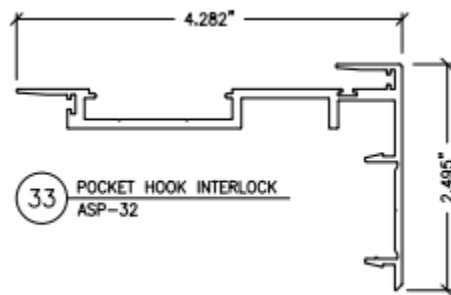
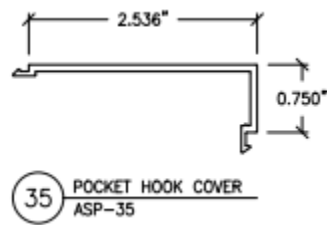
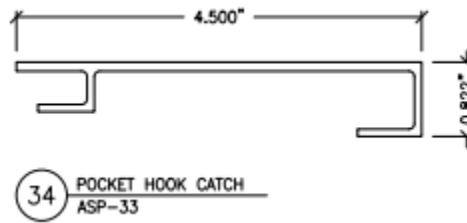
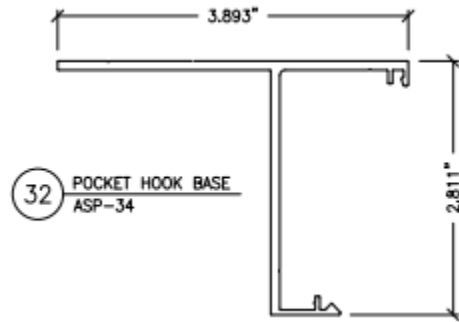

P-HOOK SPACING

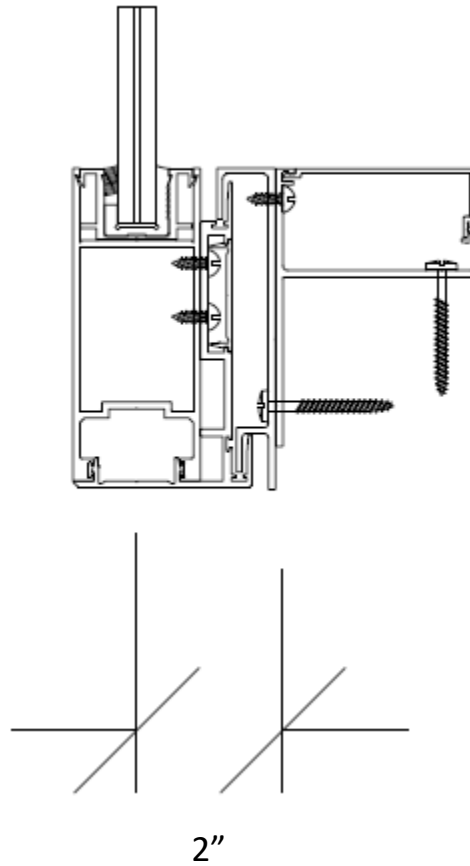

NOTE: MEASURE FROM BACK SIDE OF POCKET HOOK BASE (ASP-34) THAT MOUNTS TO WALL TO CENTER RIB OF SNAP DOOR GUIDE RAIL (AS-27)
(THIS IS THE SAME DIMENSION FOR BOTH INSIDE AND OUTSIDE POCKETS)

ADDITIONAL COMPONENTS

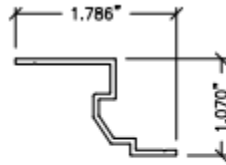

24 FIXED PANEL LOCK CLIP
AS-36

NOTE: TWO FIXED PANEL LOCK CLIPS ARE REQUIRED FOR "O" PANELS THAT ENGAGE INTO THE FRAME JAMB

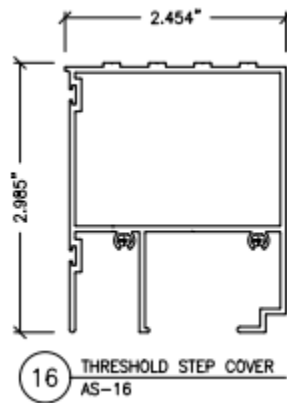

16 THRESHOLD STEP COVER
AS-16

NOTE: THRESHOLD STEP COVER IS FOR USE WITH 3-1/2 BOX STYLE (R-35) OR RETRO STYLE (RR-35) RISERS ONLY



END DAM FOR FRAME ASSEMBLY

PANEL REINFORCEMENT COMPONENTS

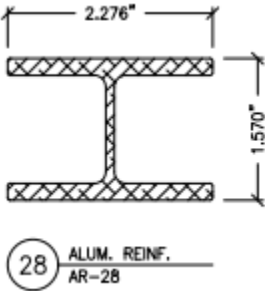

IL-3 STANDARD INTERLOCK REINFORCEMENT

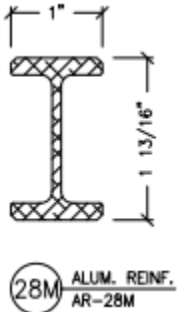

IL-3M NARROW INTERLOCK REINFORCEMENT

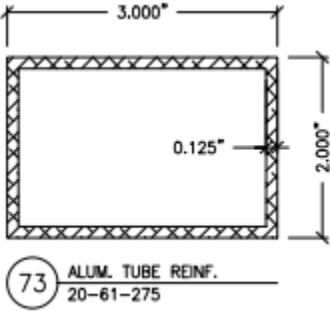

LIL-5, LIL-6 AND BS-4 BUTTSTILE REINFORCEMENT

SCREW GUIDE



#10 X 5/8" TRUSS HEAD: END DAM



#6 X 3/4" FLAT HEAD: BLU THUMB TURN



#10 X 1" PAN HEAD TEK: JAMB STRIKE PLATE



#10 X 2" PAN HEAD TEK: CENTER MEET STRIKE PLATE



#10 X 3/4" FLAT HEAD TYPE F: ROLLER AND MORTISE LOCK



#10 X 3/4" PAN HEAD TEK: Z-CLIP



#10 X 1/2" PAN HEAD TEK: P-HOOK BASE TO P-HOOK CATCH



#10 X 3/4" FLAT HEAD TYPE F: PANEL COME A LONG AND CREST THUMB TURN



#12 X 1-1/2" PAN HEAD: PANEL, FRAME AND SCREEN ASSEMBLY



#8 X 3/4" TRUSS HEAD: CENTER MEET SCREEN KEEPER



#6 x 1-1/4" FLAT HEAD: JAMB STYLE SCREEN KEEPER

GLAZING GASKETS



52 9/16" WET GLAZE GASKET
EPDM-52

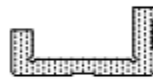

53A 1-3/16" WET GLAZE STILE GASKET
EPDM-53A



53B 1-3/16" WET GLAZE RAIL GASKET
EPDM-53B

GLAZING SILICONE



DOWSIL 791

STANDARD HANDLE OPTIONS



CREST® HANDLE



CREST® THUMB TURN



INVISIO® HANDLE

HANDLE HARDWARE



CREST® HANDLE INSTALLATION SCREW

BREAK POINT FOR SINGLE SIDE HANDLE

BREAK POINT FOR INSIDE/OUTSIDE HANDLE SET

2 x M5 x 82 Hex
Snap-off



M5 RIVET NUT



CREST® HANDLE WASHER FOR INSIDE/OUTSIDE HANDLE SET



CREST® HANDLE WASHER FOR SINGLE SIDE HANDLE



CREST® 2.5MM GRUB SCREW

LOCK COMPONENTS



SBML® DUAL MORTISE LOCK



ADJUSTABLE STRIKE PLATE

WEATHERSTRIP GUIDE

SLIDING GLASS DOORS

ALL PANEL AND ACCESSORY COMPONENTS - .187" X .200" TRIFIN®

SCREEN

SCREEN SWEEP - .187" X .170" ULTRAPILE®

SCREEN TOP AND BOTTOM RAILS – .187" X .130" ULTRAPILE®

ADDITIONAL PARTS



SILL WEEP GATE



ULTRAPLUG® AIR STOP



ULTRAFIN® AIR STOP



ULTRAPILE® AIR STOP



ADJUSTMENT HOLE COVER



TANDEM 2.125" ROLLER (POLYMER OR STAINLESS)

2T SILL DEPTH

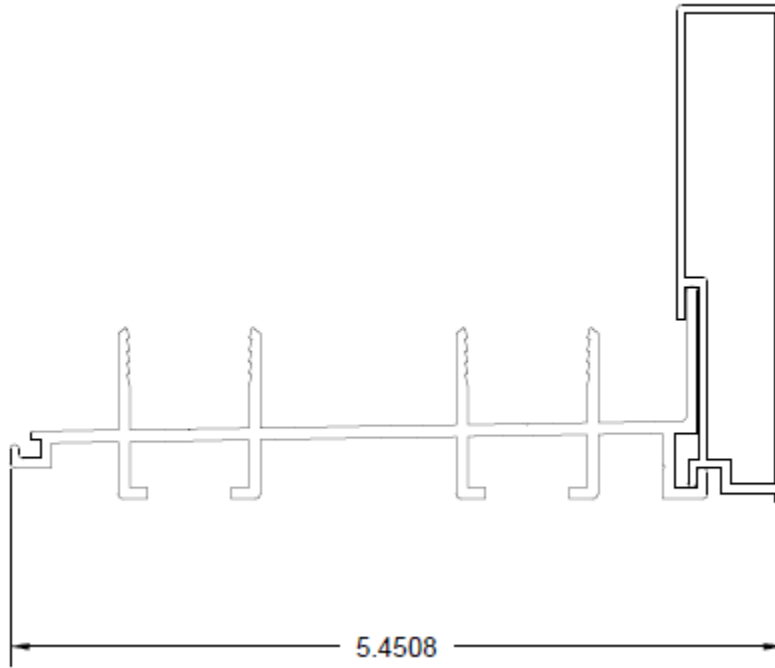

2TWS SILL DEPTH

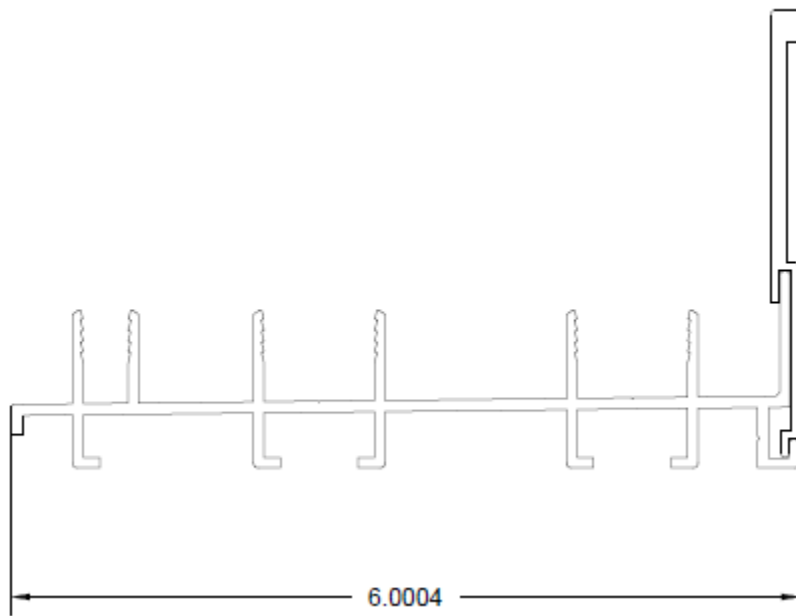
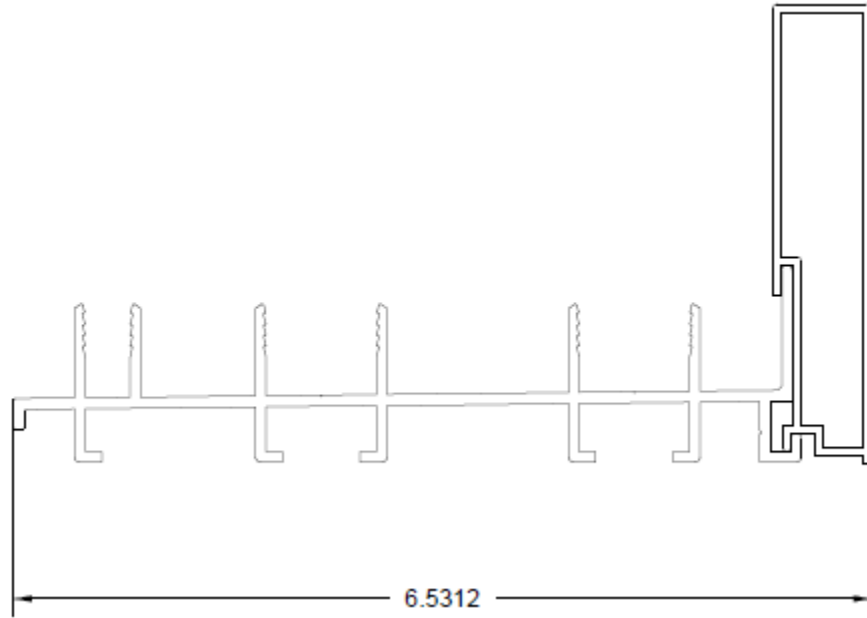

3T SILL DEPTH

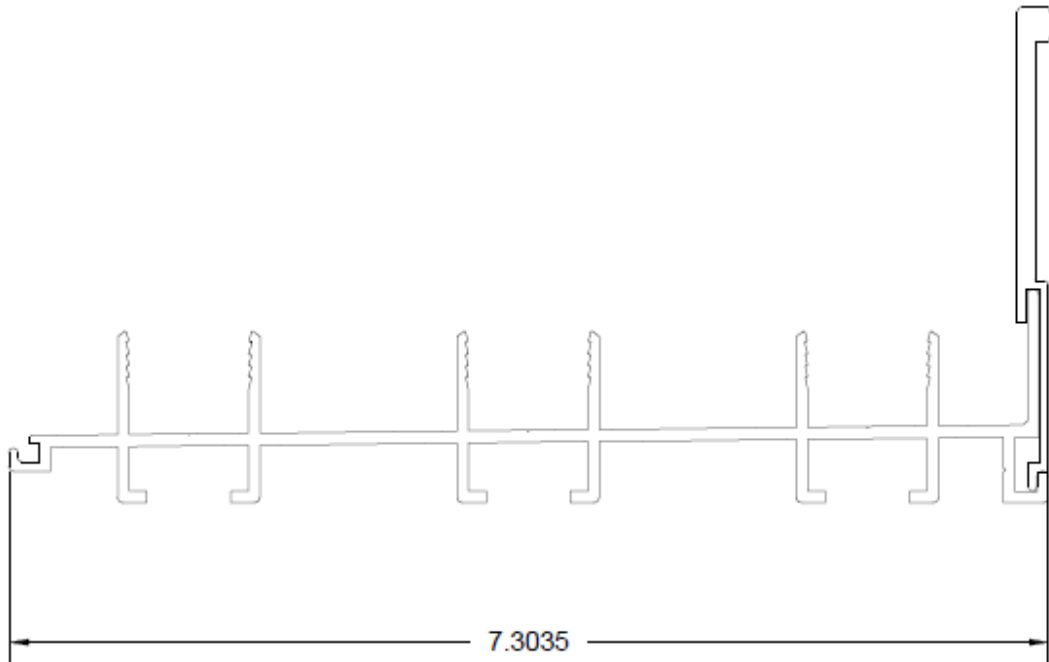
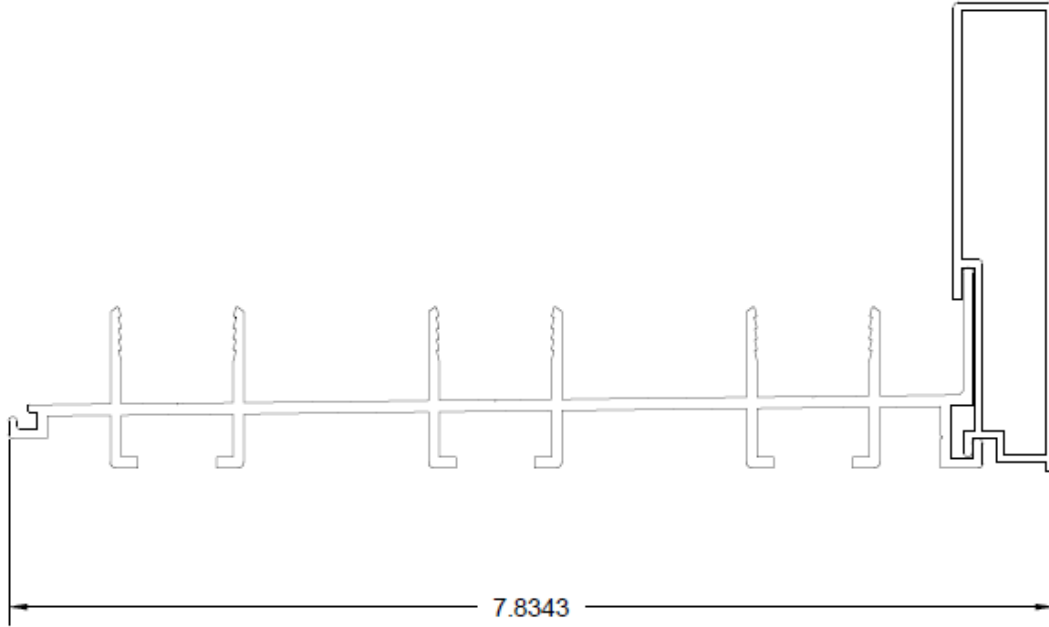

4T SILL DEPTH

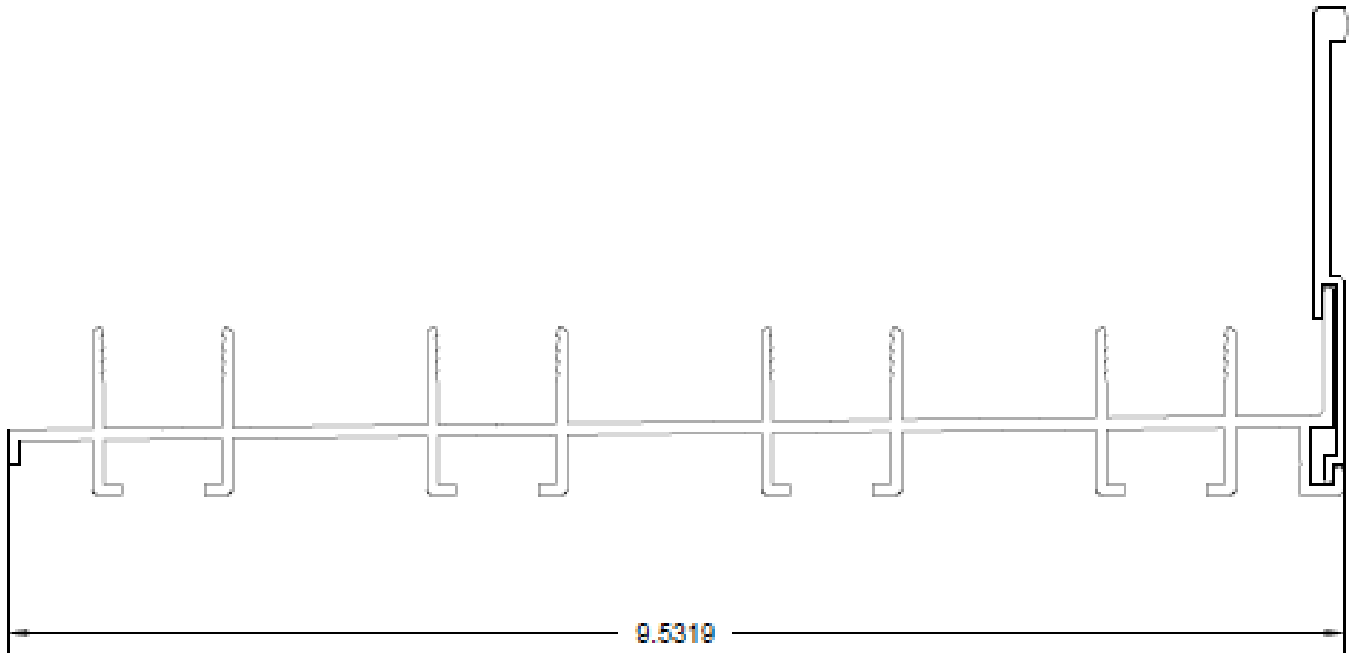
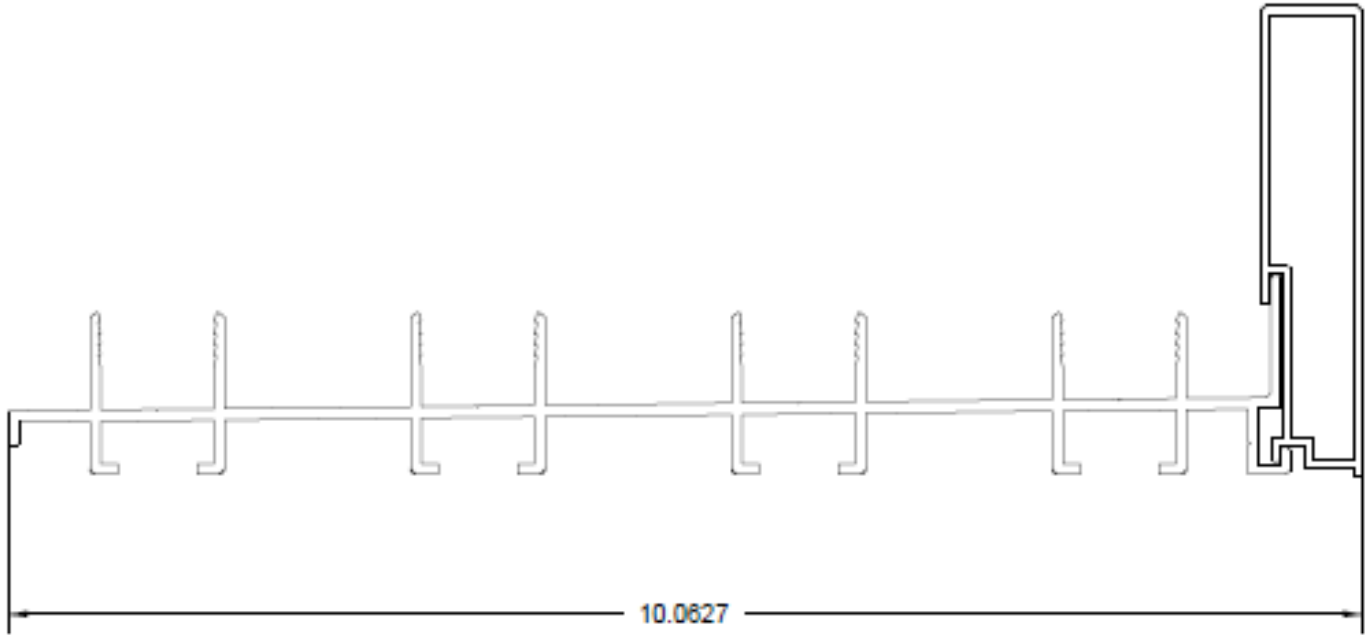

5T SILL DEPTH

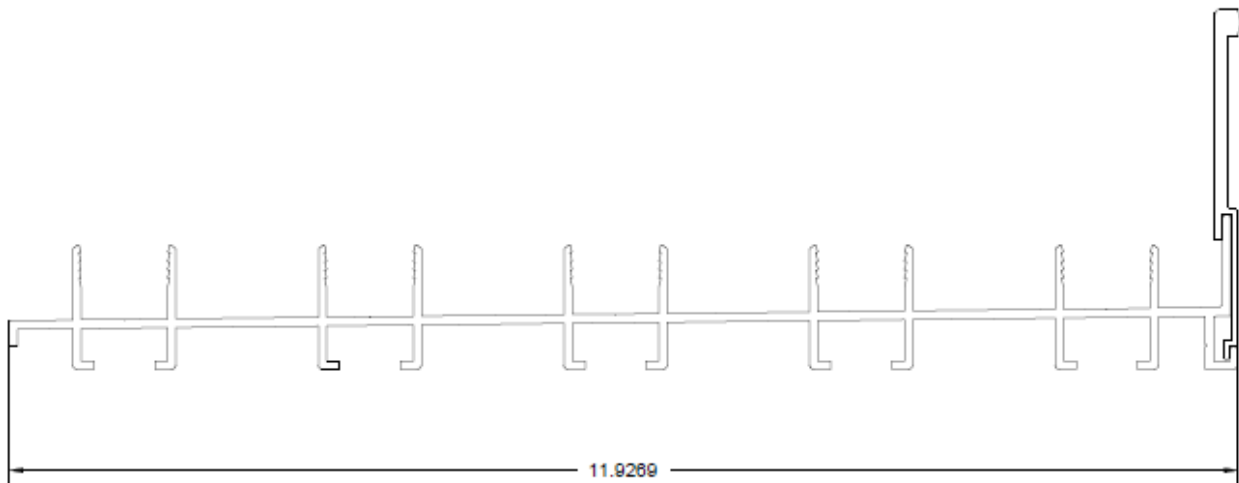
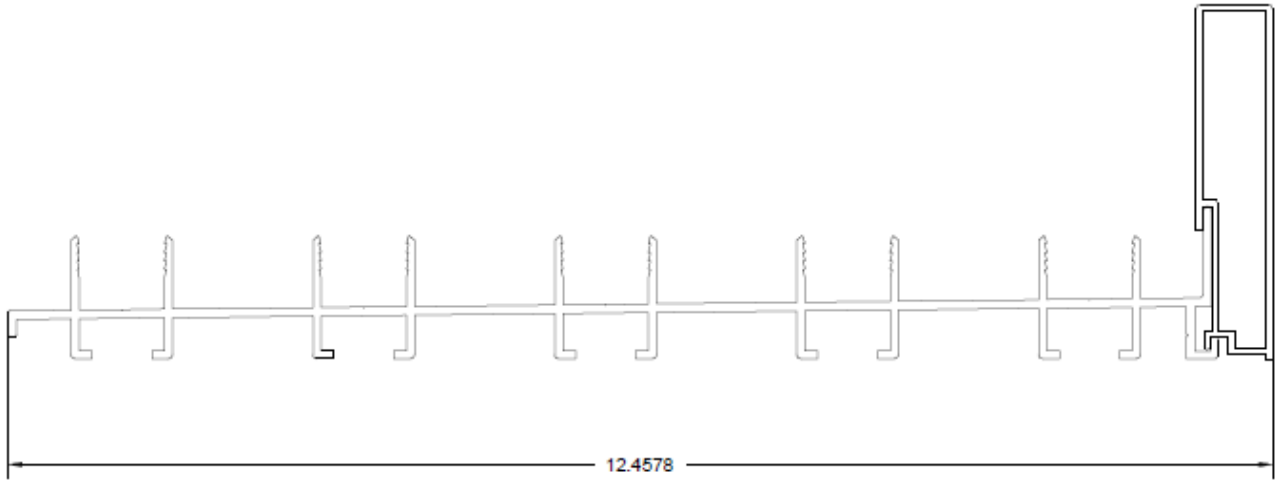

PANEL DESIGNATIONS

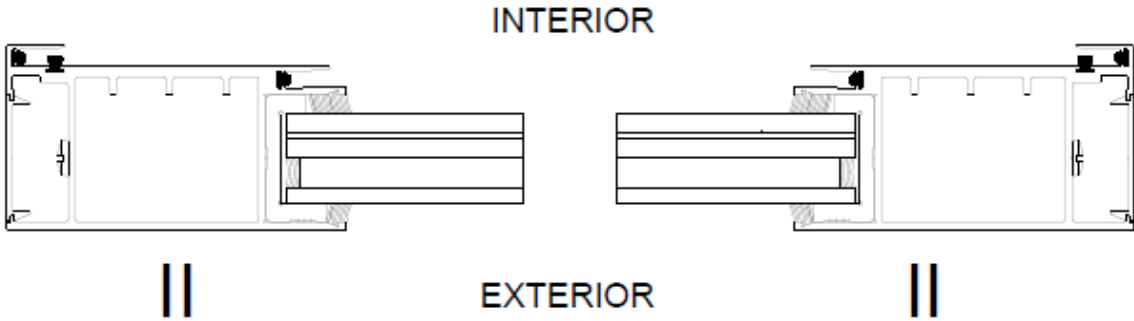
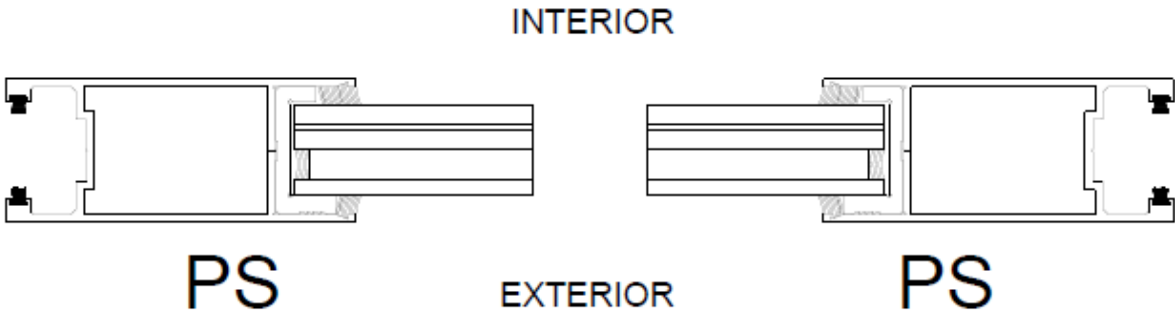
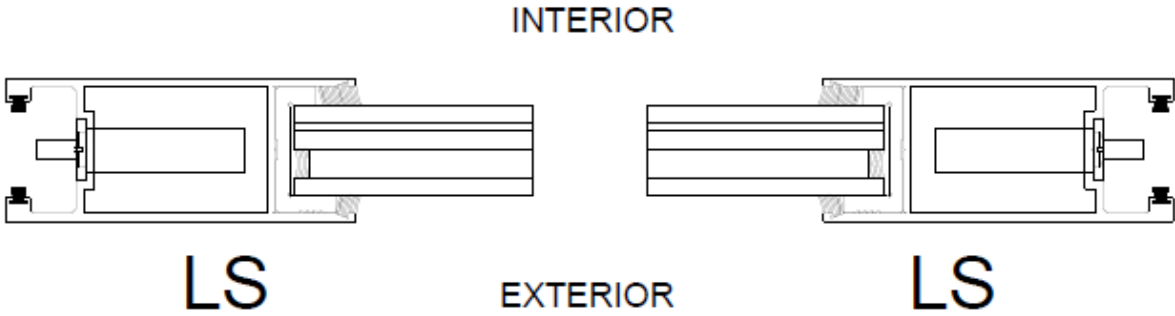

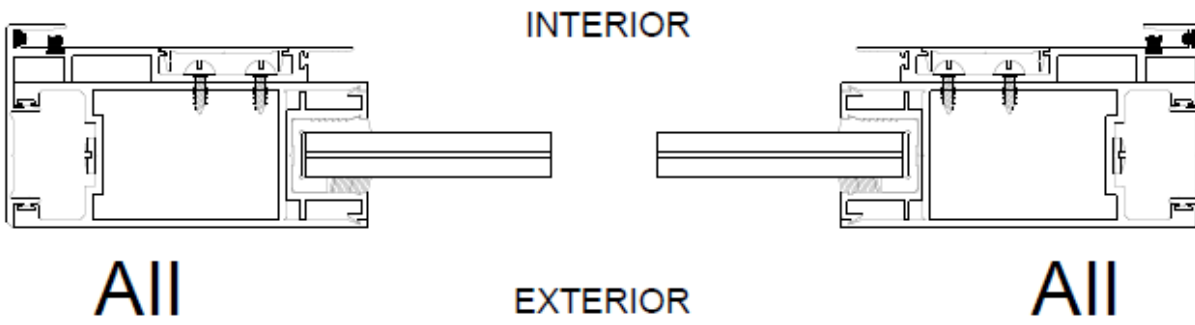
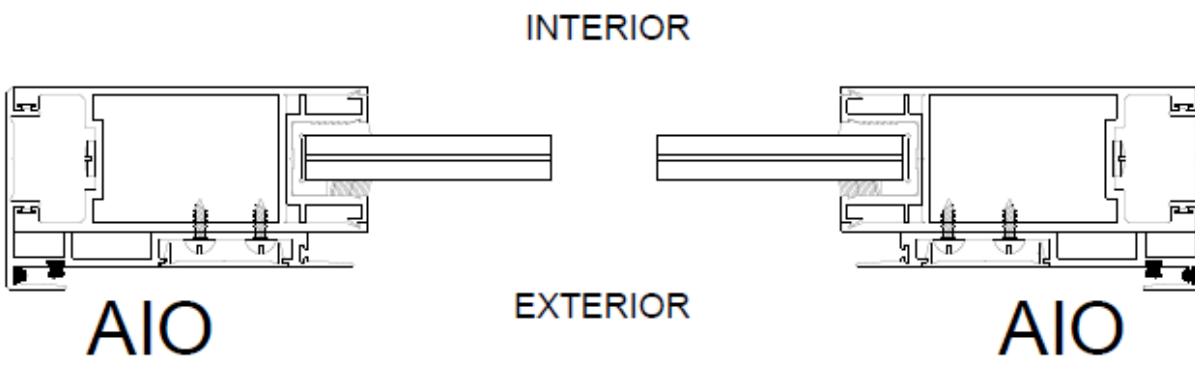
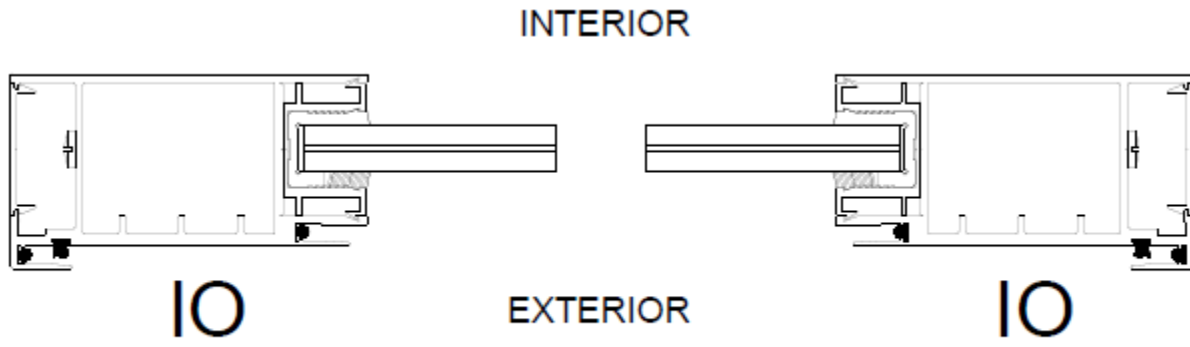

INTERIOR

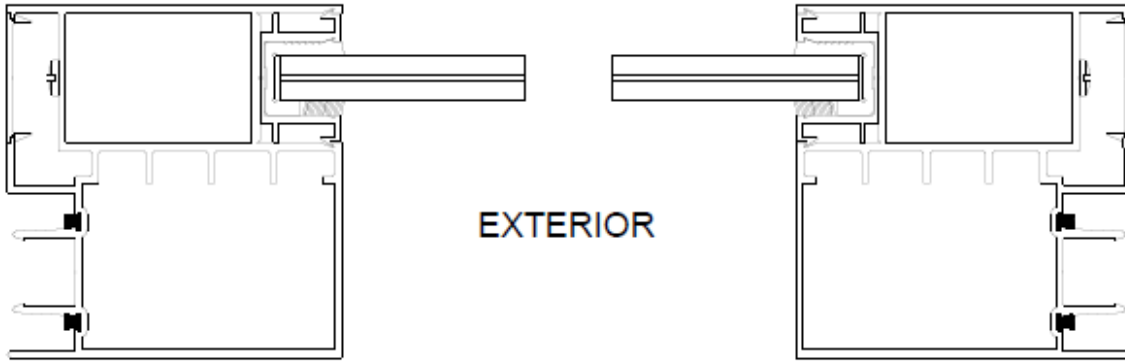

EXTERIOR

EOB

EOB

INTERIOR

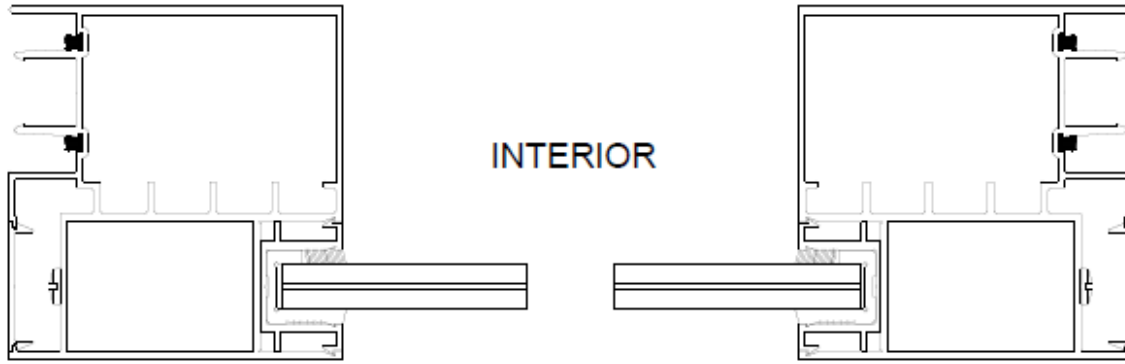

EXTERIOR

IOB

IOB

INTERIOR

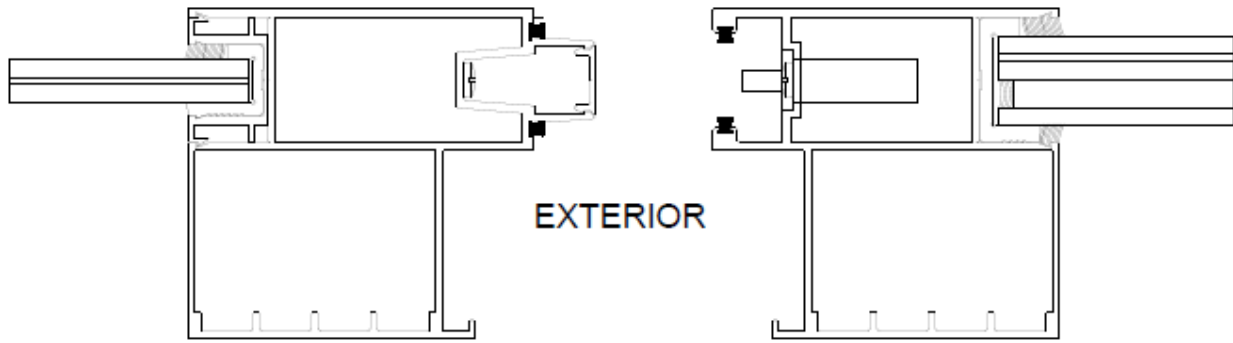

EXTERIOR

EMB

ELB



EXPLORE MORE COMPANY AND PRODUCT INFORMATION ON OUR WEBSITE AT
WWW.VELOCITYIMPACTPRODUCTS.COM



FIND INSTALLATION AND PRODUCT INFORMATION VIDEOS ON OUR YOUTUBE
CHANNEL